

Farmmodels.nl

Landbouwminiaturen ~ Onderdelen ~ Bouwkitjes ~ Stickers ~ Dioramabouw

*Jan Veenhuis opzetransd t.b.v. Silagebak 3 assen Haakarm
nr. 40125*

bouw handleiding



Beste modelbouwer,

bedankt voor de aanschaf van een Farmmodels bouwpakket.

U heeft hier de gedetailleerde beschrijving van uw bouwkit in schaal 1:32
In fases wordt stap voor stap uitgelegd hoe u alle onderdelen samenstelt.

Lees eerst alle fases goed door, voordat u begint.

Het meeste freeswerk zit in de plaat vast met "bridges", dat zijn kleine stukjes om de gefreesde onderdelen in de plaat vast te houden.

Snij door deze bridges heen om de onderdelen los te maken.

Schoon daarna waar nodig het freeswerk op, verwijder eventuele resten en vijl alle scherpe hoeken / randen wat af.

Dat bevordert later het spuitwerk...

In deze beschrijving is niet aangegeven wanneer u het beste onderdelen van kleur / verf kunt voorzien, daar dit afhankelijk is van de door u gekozen kleurstelling. Hou daar zelf rekening mee tijdens de bouw.

Belangrijk is de juiste soort lijm te gebruiken.

Wij adviseren 2 soorten lijm:

Modelbouwlijm voor polysyreen (plastic / kunststof is Revell Contacta en secundelijm / industrie lijm.

Gedurende de bouw wordt verteld met welke lijm gewerkt dient te worden.

Deze handleiding is zo goed mogelijk samengesteld.

Mocht u derhalve toch vragen hebben, of punten opmerken ter verbetering van de handleiding, kunt u ons mailen op info@farmmodels.nl.

Wij wensen u veel "modelbouw" plezier met het samenstellen van dit model.

Met vriendelijke groet,
Team Farmmodels.nl

Benodigheden voor de bouw:

Voor de bouw van onze kitjes is het makkelijk om over het volgende gereedschap te beschikken:

* Revell mes of Stanley mes



* Vijl en schuurpapier



* Pincet



* Zijkniptang



* Punt tang



* diverse (staal) boortjes



• Lijm

○ Modelbouwlijm,



Advies: Revell Vloeibare plasticlijm.

Deze lijm droogt niet direct en geeft de mogelijkheid om delen te positioneren.

○ Secondelijm



Advies: Farmmodels super lijm.

Deze lijm droogt direct zodat delen niet lang vastgehouden hoeven te worden.

Gedurende de bouw wordt aangegeven welke lijm het meest geschikt is.



1: **Start:**



2:

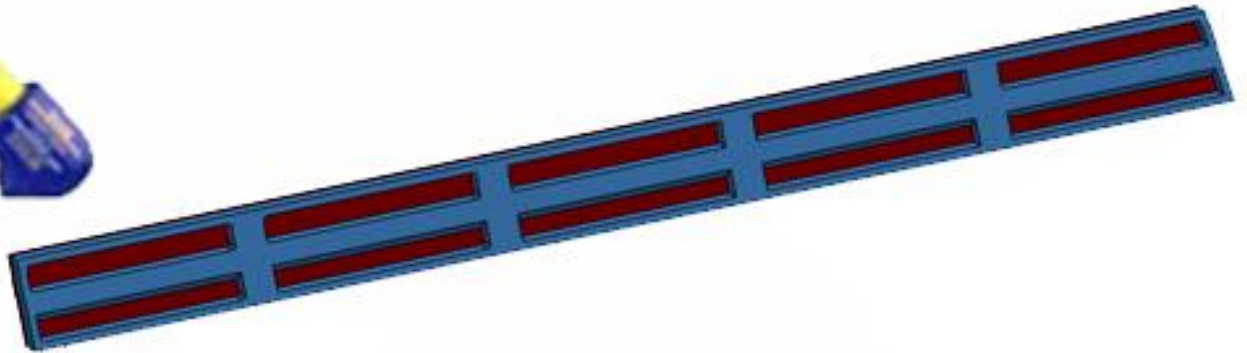

10x

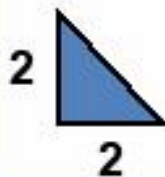

Polystyreen 2x2 mm

3:

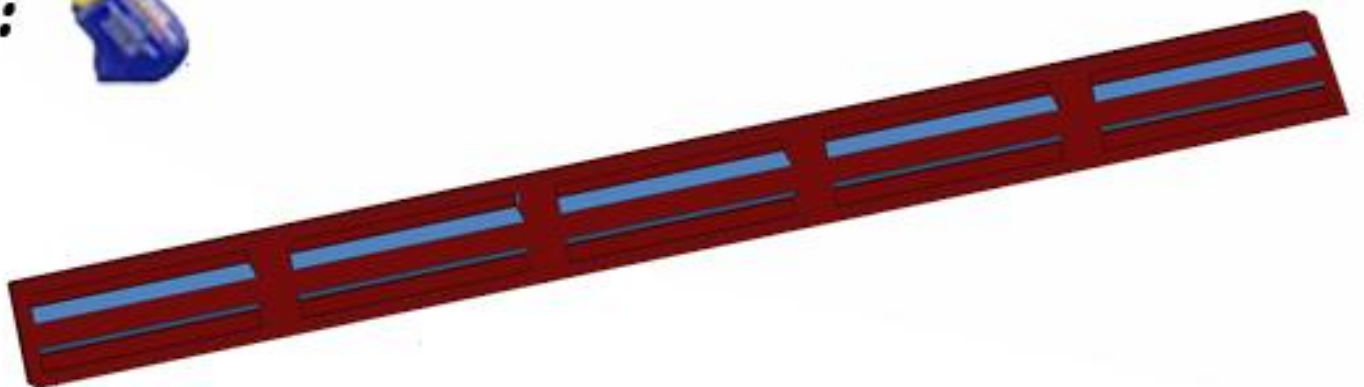



IJzerdraad as
Iron axle
Ø 0.9 mm

5:

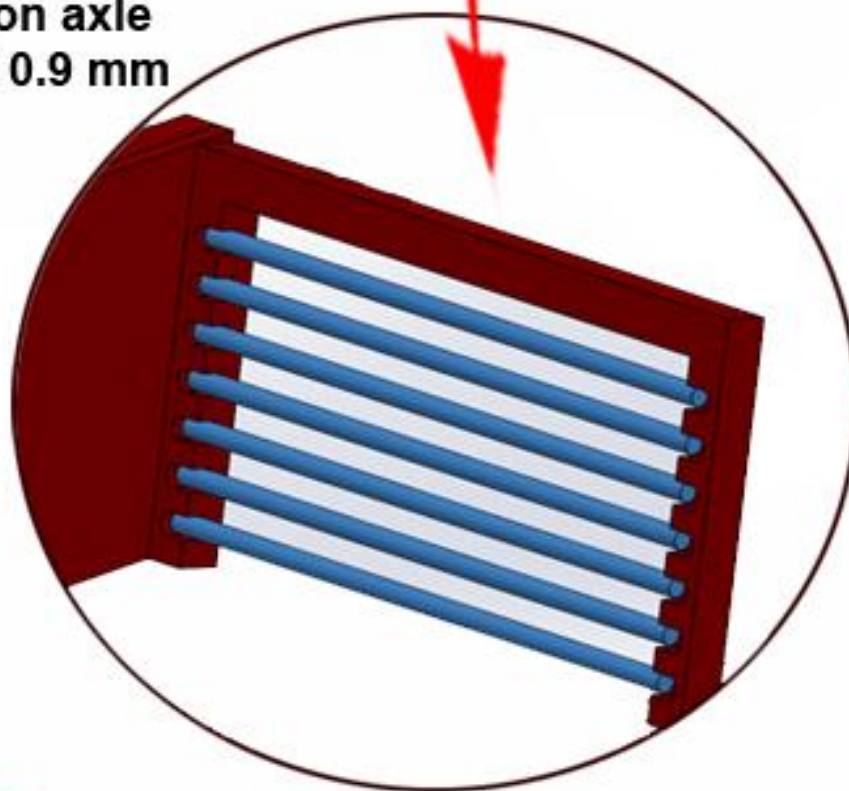

6:





Farmmodels.nl

Landbouwmodellen - Onderdelen - Bevestiging - Stickers - Diermodellen



Jan Veenhuis opzetrand e.b.v. Silagebak 3 assen Haakarm nr. 40125



7:

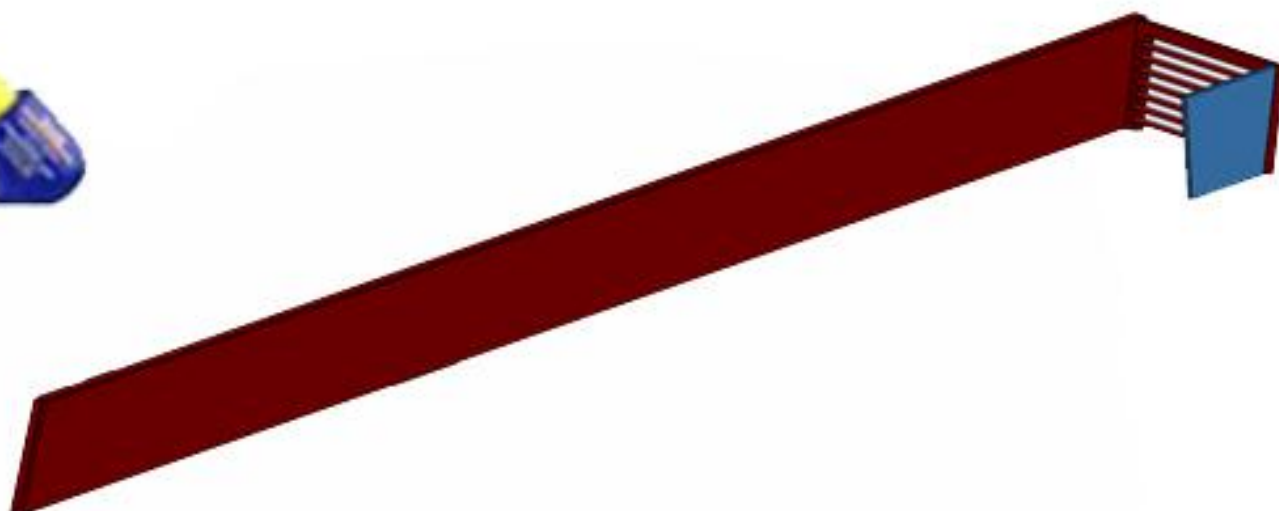

8:

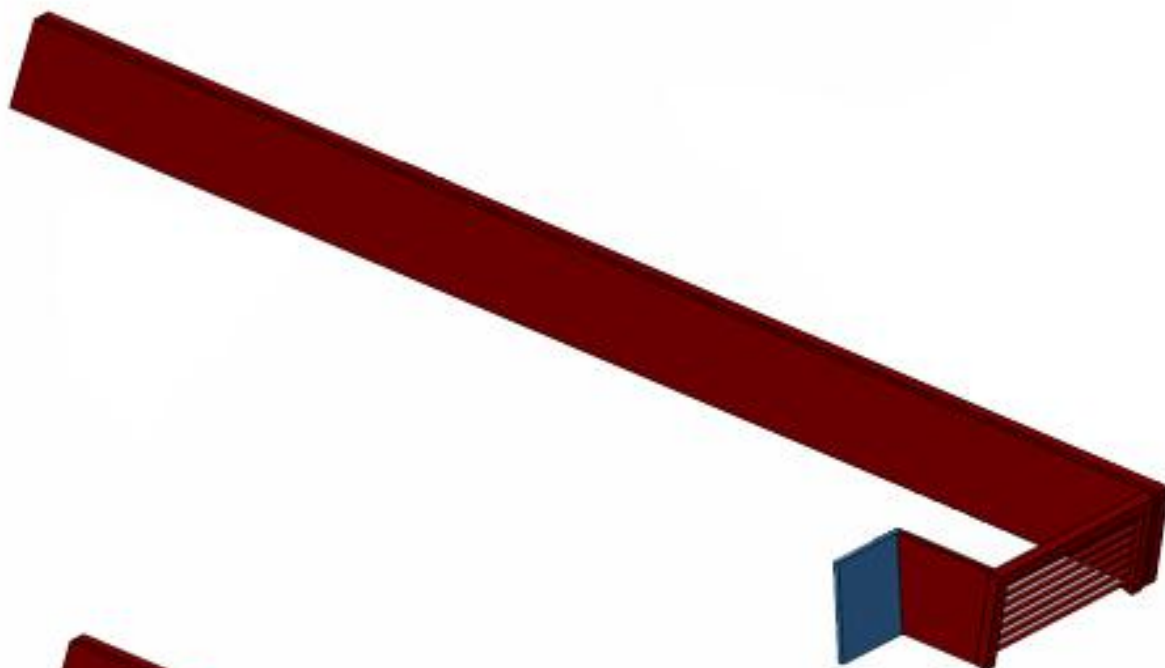

9:

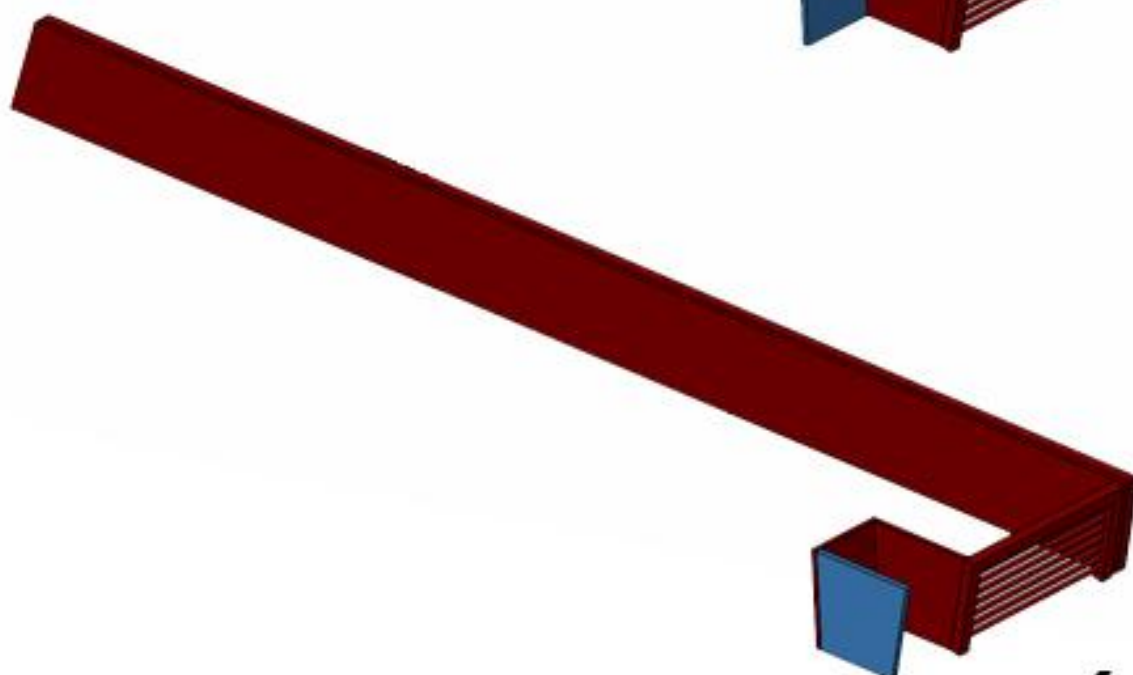

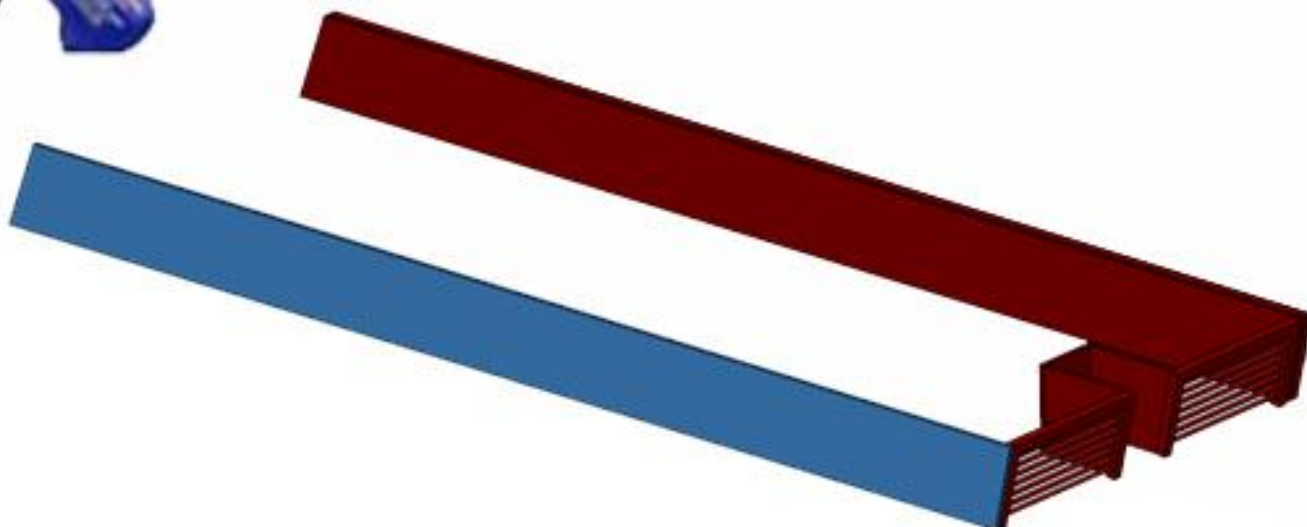
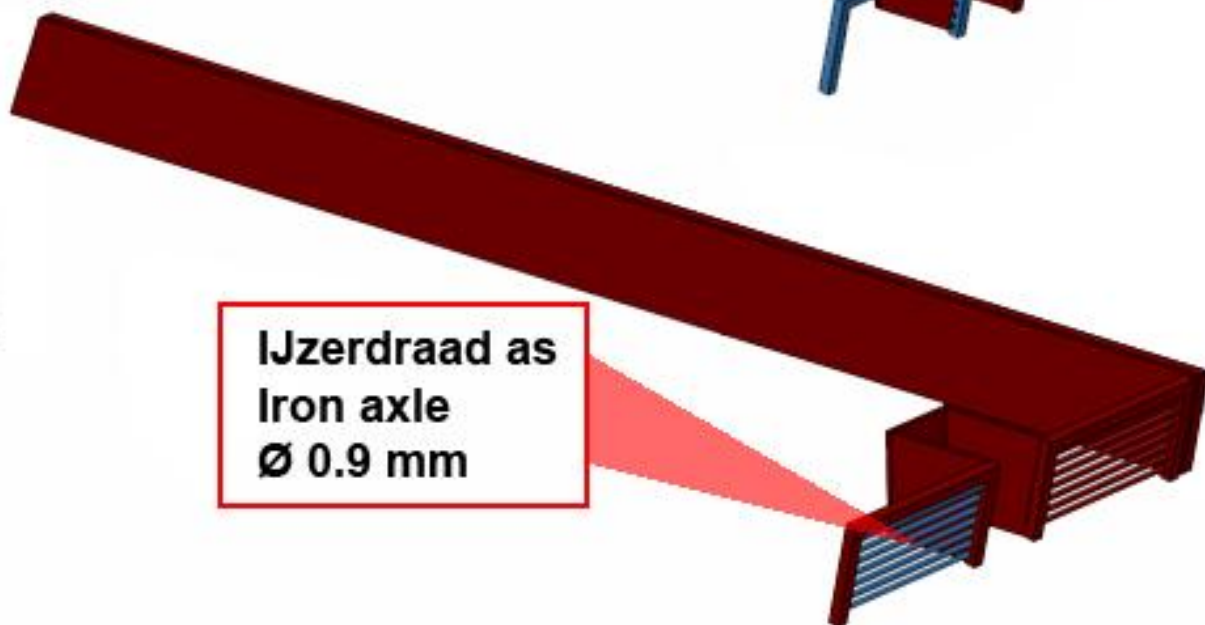

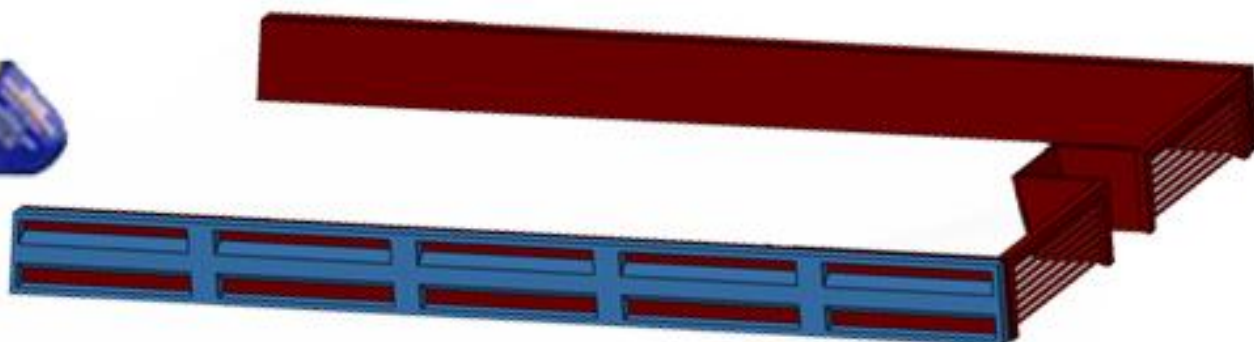

14:



2x

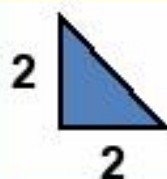

Polystyreen 2x2 mm

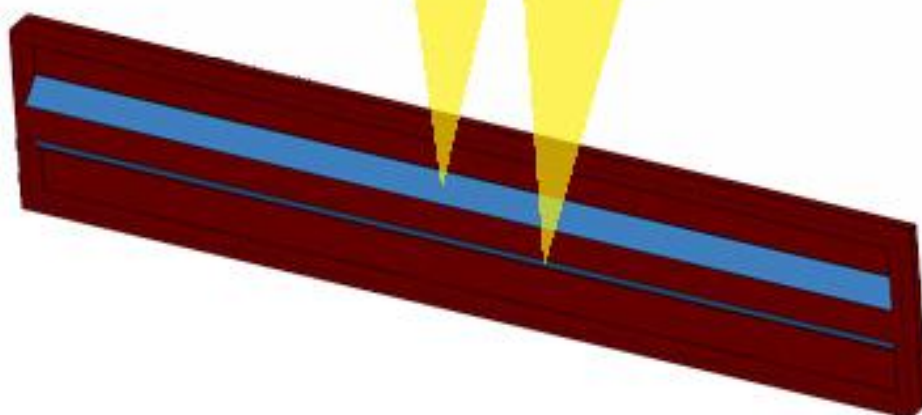

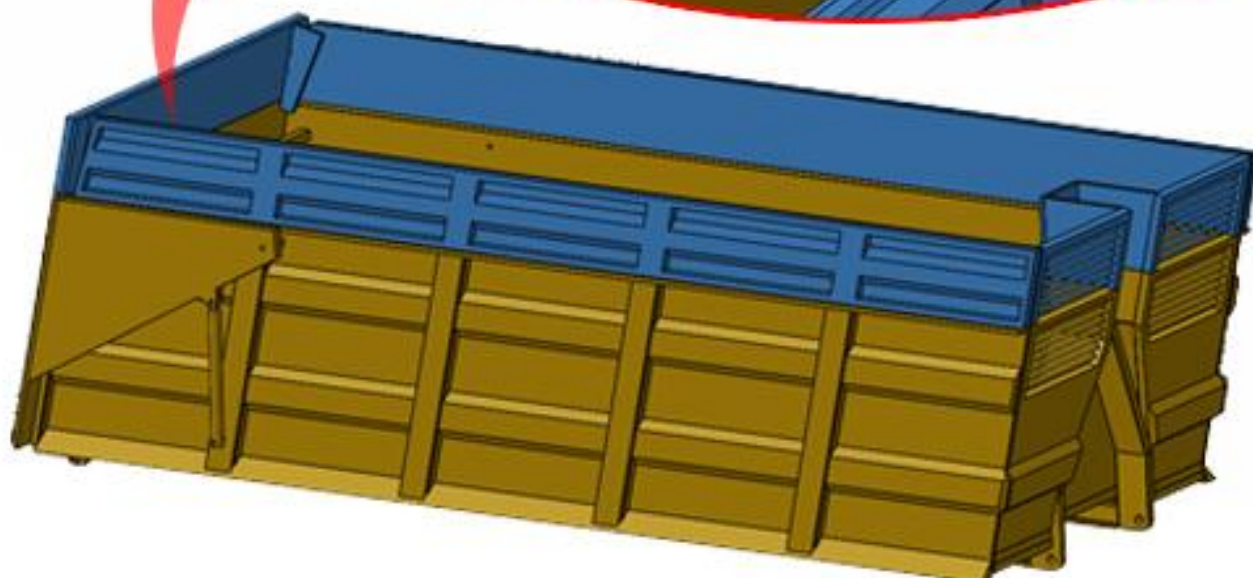
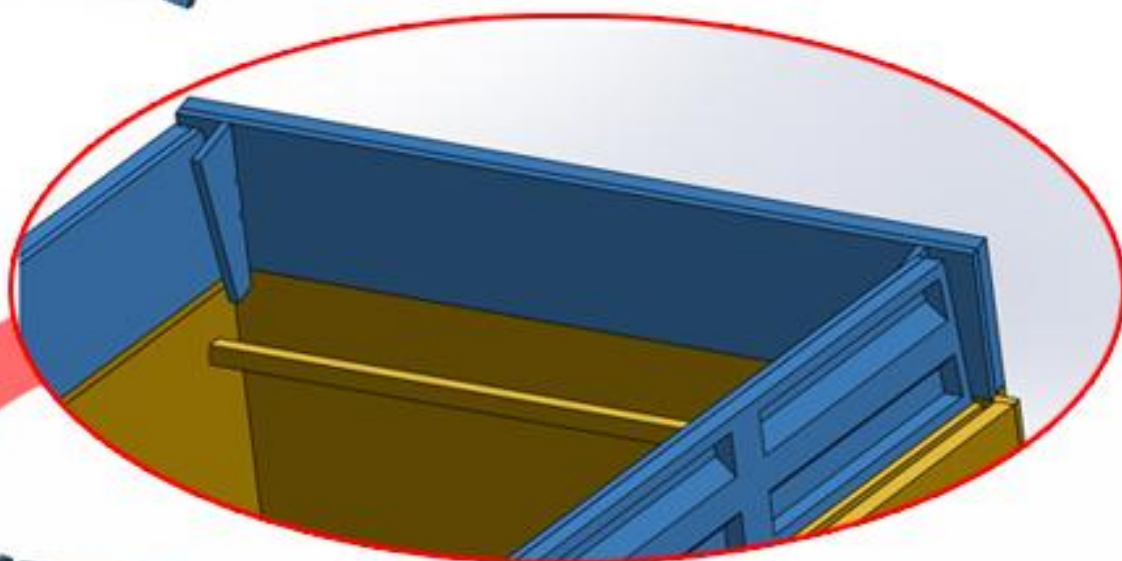
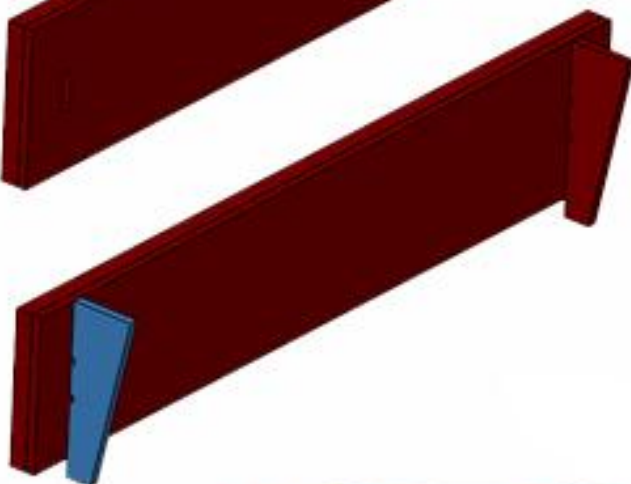



Farmmodels.nl

Landbouwmachines - Onderdelen - Bouwplannen - Stokers - Bioruimtes



Jan Veenhuis opzetrand e.b.v. Silagebak 3 assen Haakarm nr. 40125

20:

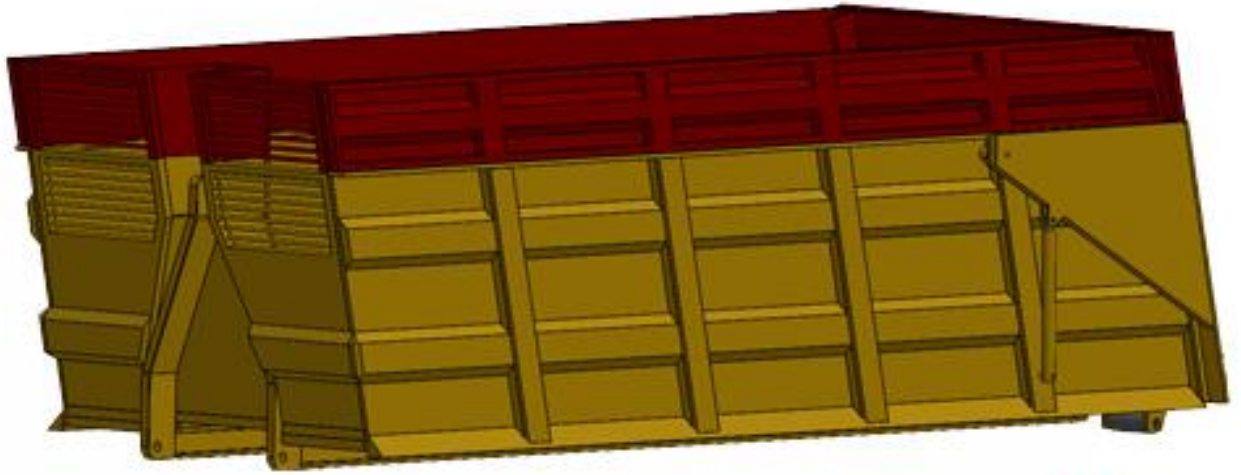

*Klaar !!!
Ready !!!*

