

## CONSTRUCTION MANUAL

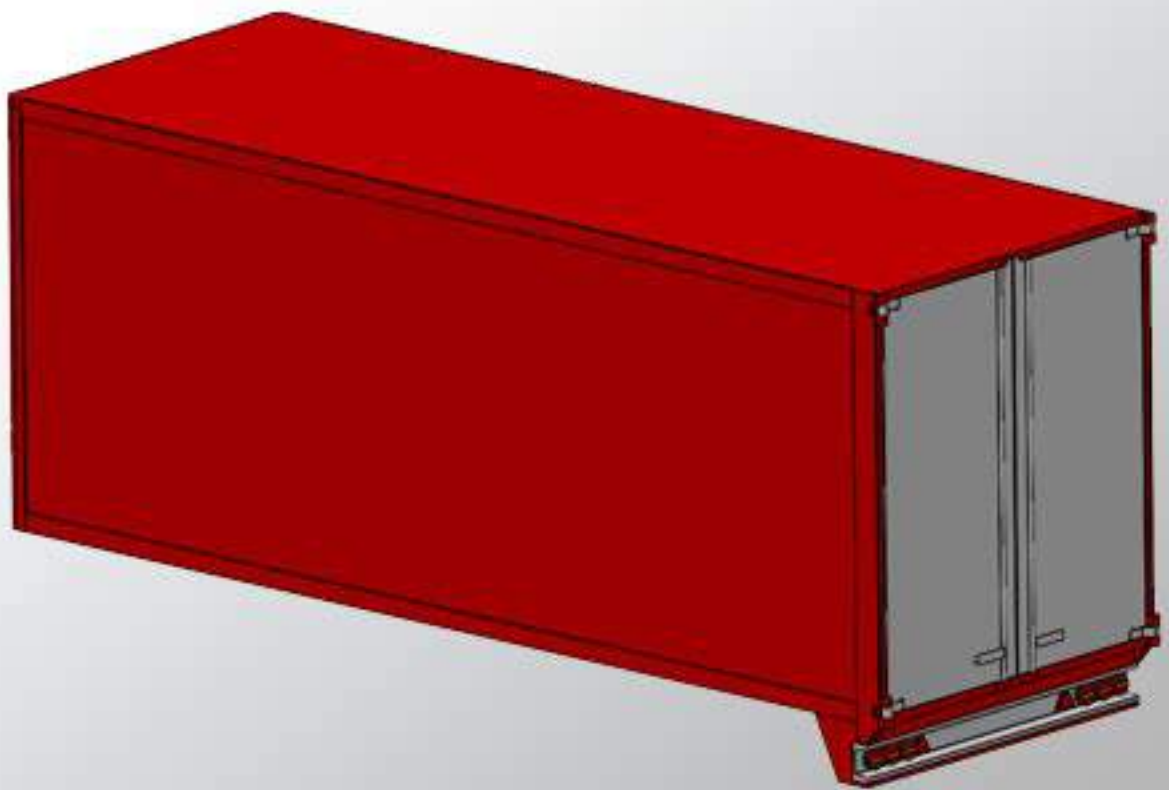

**Farmmodels.nl**

*Premium line*

## Volvo truck bakopbouw

---

# INLEIDING

---

Beste modelbouwer,

Bedankt voor de aanschaf van een Farmmodels bouwpakket.

U heeft hier de gedetailleerde beschrijving van uw bouwkit in schaal 1:32.  
In fases wordt stap voor stap uitgelegd hoe u alle onderdelen samenstelt.

**Lees eerst alle fases goed door, voordat u begint.**

Het meeste freeswerk zit in de plaat vast met “bridges”, dat zijn kleine stukjes om de gefreesde onderdelen in de plaat vast te houden.

Snij door deze bridges heen om de onderdelen los te maken.

Schoon daarna waar nodig het freeswerk op, verwijder eventuele resten en vijl alle scherpe hoeken / randen wat af.

Dat bevordert later het spuitwerk...

In deze beschrijving is niet aangegeven wanneer u het beste onderdelen van kleur / verf kunt voorzien, daar dit afhankelijk is van de door u gekozen kleurstelling. Hou daar zelf rekening mee tijdens de bouw.

Belangrijk is de juiste soort lijm te gebruiken.

Wij adviseren 2 soorten lijm:

Modelbouwlijm voor polystyreen (plastic / kunststof) is Revell Contacta en secundelijm / industrie lijm.

Gedurende de bouw wordt verteld met welke lijm gewerkt dient te worden.

Deze handleiding is zo goed mogelijk samengesteld.

Mocht u derhalve toch vragen hebben, of punten opmerken ter verbetering van de handleiding, kunt u ons mailen op [info@farmmodels.nl](mailto:info@farmmodels.nl).

Wij wensen u veel “modelbouw” plezier met het samenstellen van dit model.

Met vriendelijke groet,  
Team Farmmodels.nl

---

# INTRODUCTION

---

Dear modeller,

Thank you for purchasing a Farmmodels kit.

Here you have the detailed description of your kit in scale 1:32.

The manual explains all the stages step by step how to use the different parts.

**Please read all stages thoroughly before you begin.**

Most parts in this kit are attached on a plate with 'bridges'.

This is to protect the parts from damaging.

Cut through these bridges in order to detach the parts.

Clean up the parts where necessary and remove any residue and file all sharp corners/edges.

This kit does not indicate at what point you should colour/paint the parts, because this depends on your choice of colour palette.

Keep that in mind during the construction of your model.

It is important to use the right type of glue.

We recommend two types of glue:

Model making glue for polystyrene (plastic) Revell Contacta and superglue/industrial glue.

This manual has been prepared with great care and preciseness.

Should you therefore still have questions or points for improvement concerning the manual, please contact us by e-mail via [info@farmmodels.nl](mailto:info@farmmodels.nl)

We wish you good "modeling" fun with composing this model.

Sincerely,

team Farmmodels.nl

# Benodigdheden - Tools

Voor de bouw van onze kitjes is het makkelijk om over het volgende gereedschap te beschikken:

For the construction of our kit we recommend the following tools:

Revell mes - Revell knife



Pincet - Tweezers



Punt tang Pliers



Revell lijm - Revell glue



Advies: Revell Vloeibare plasticlijm.

*Deze lijm droogt niet direct en geeft de mogelijkheid om delen te positioneren.*

Advice: Revell Liquid plasticglue.

*This glue doesn't dry instantly and gives the possibility to position the parts.*

Vijl - File



Boortjes - Drill bits



Zijkniptang - Side cutter



Superlijm - Superglue



Advies: Farmmodels superlijm

*Deze lijm droogt direct zodat delen niet lang vastgehouden hoeven te worden.*

Advice: Farmmodels Superglue.

*This glue dries instant so that parts don't need to be held long.*

# 1 Start

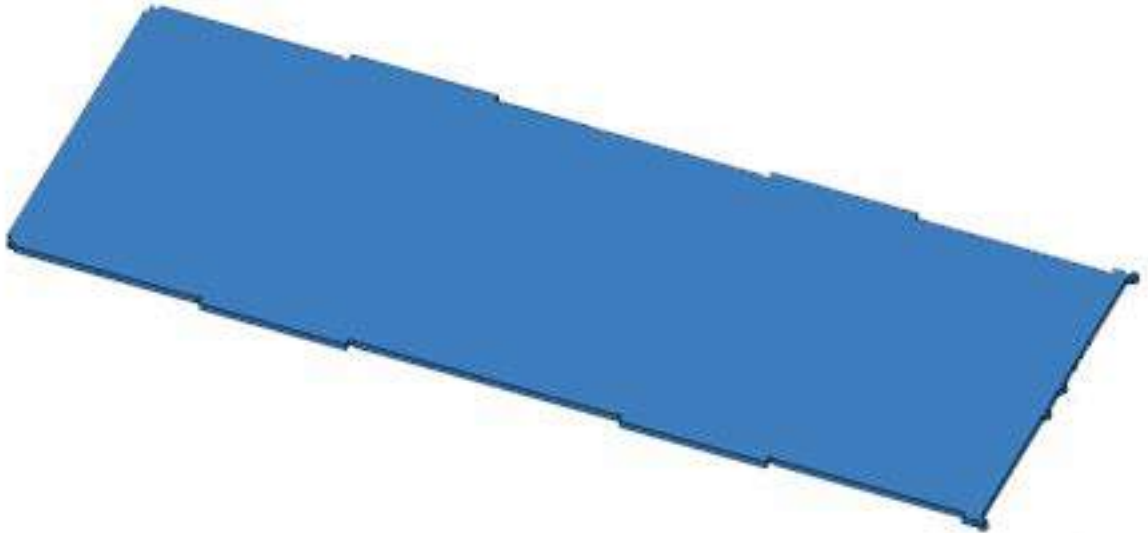

2

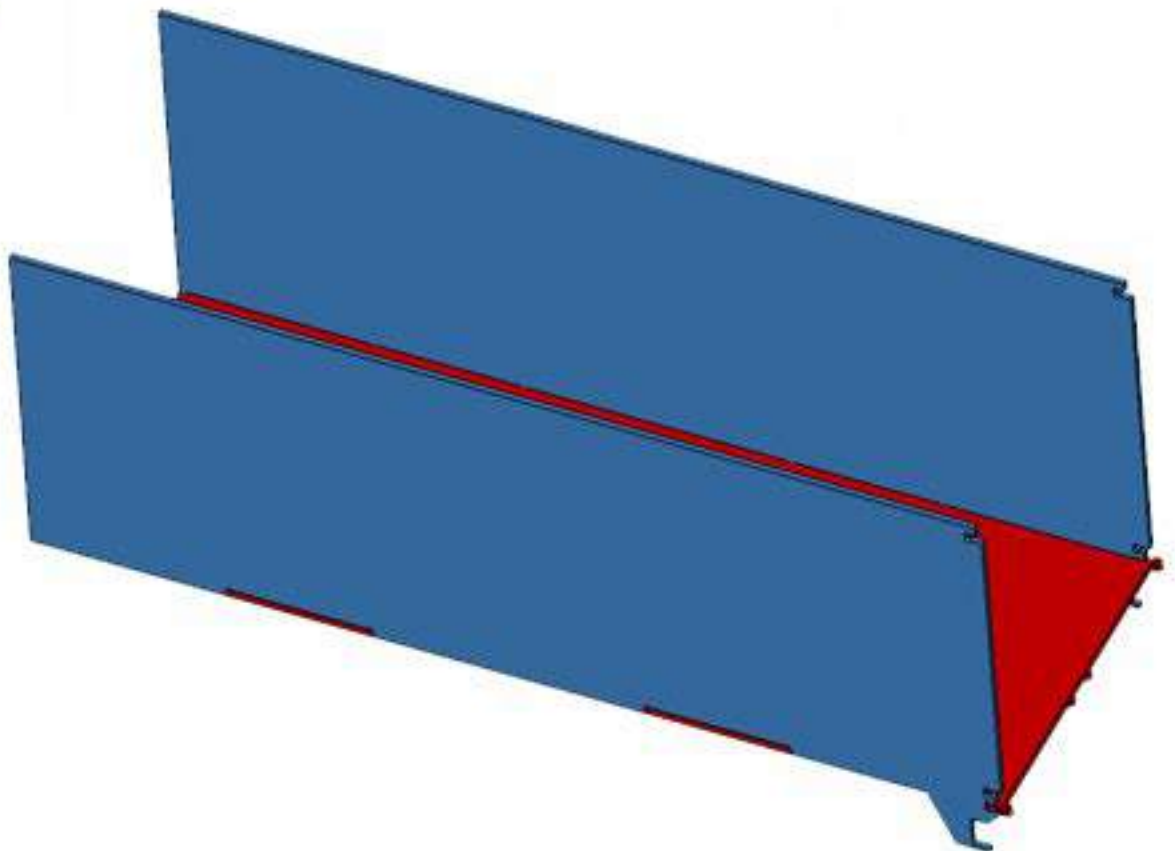

**3**

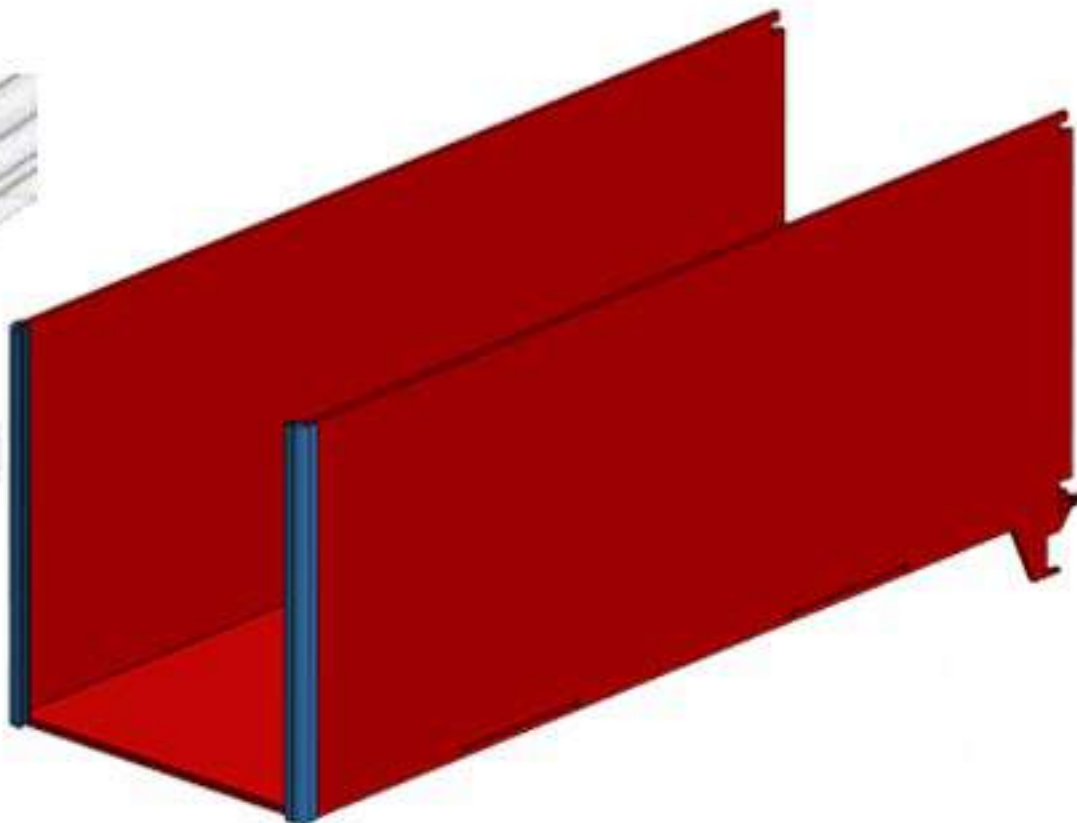

**Gebruik half rond profiel, lengte = hoogte zijkant bak**  
**Use half round profile, length = height trailer side**

**4**

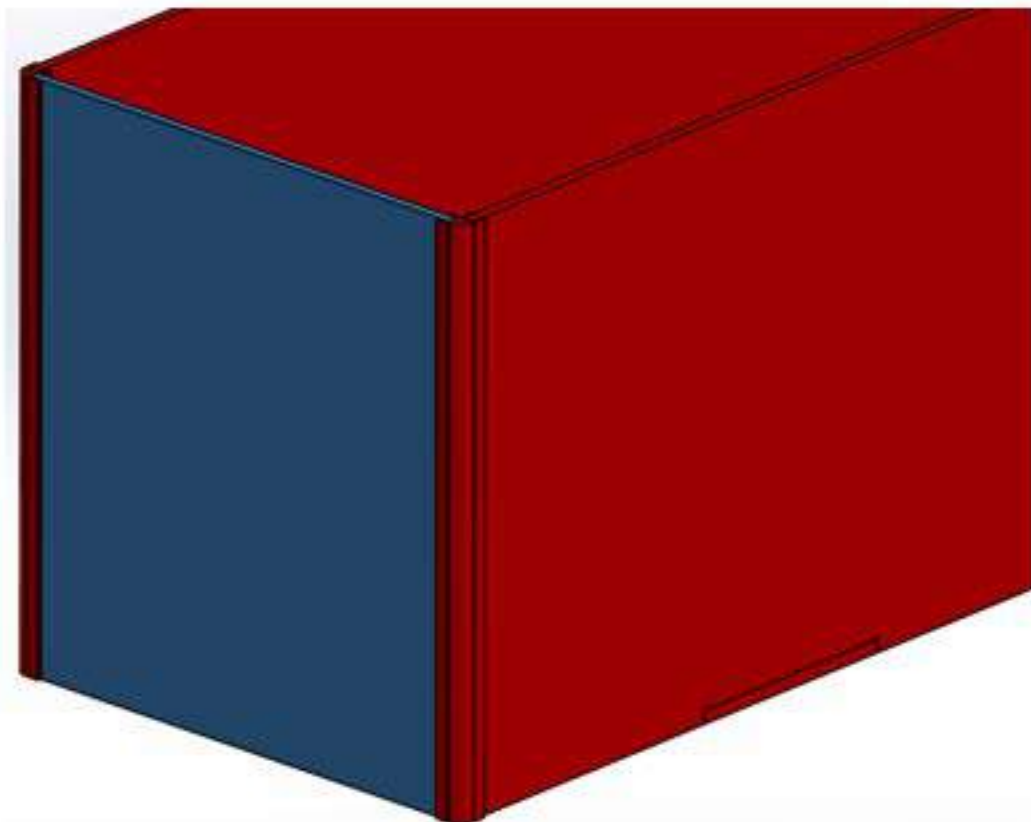

**5**

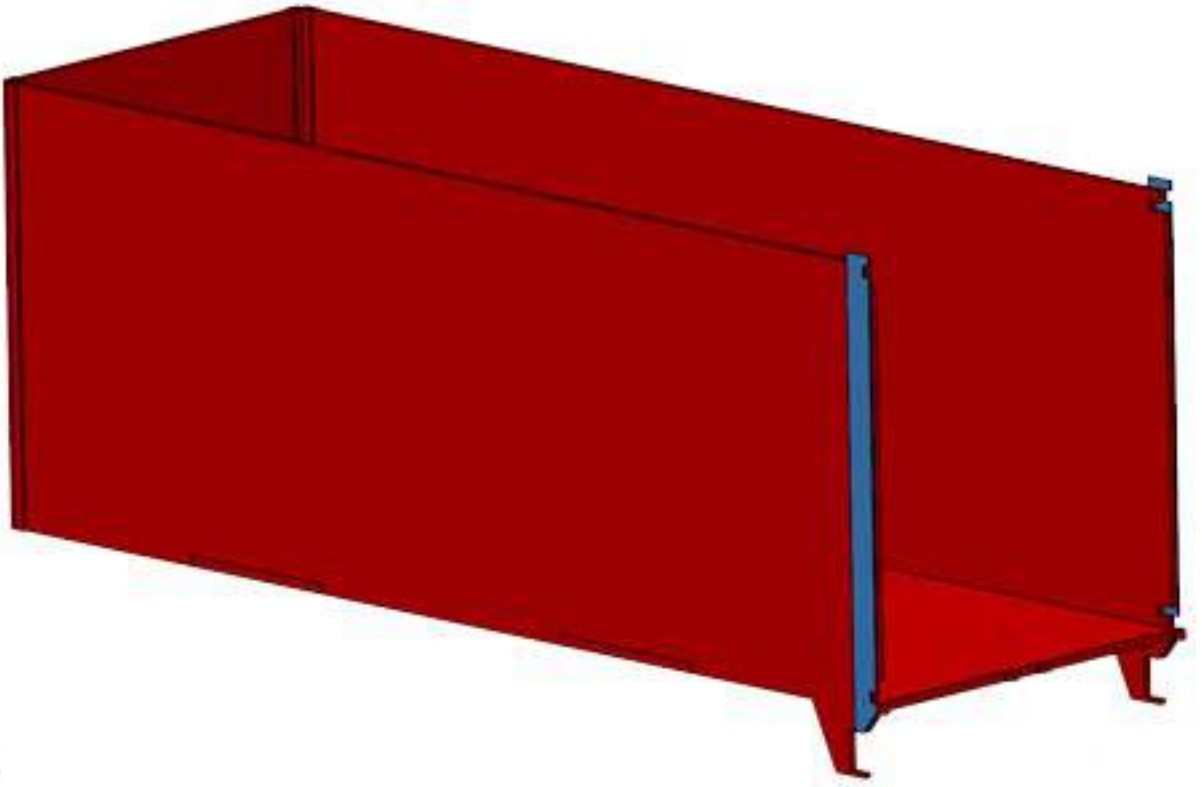

**6**

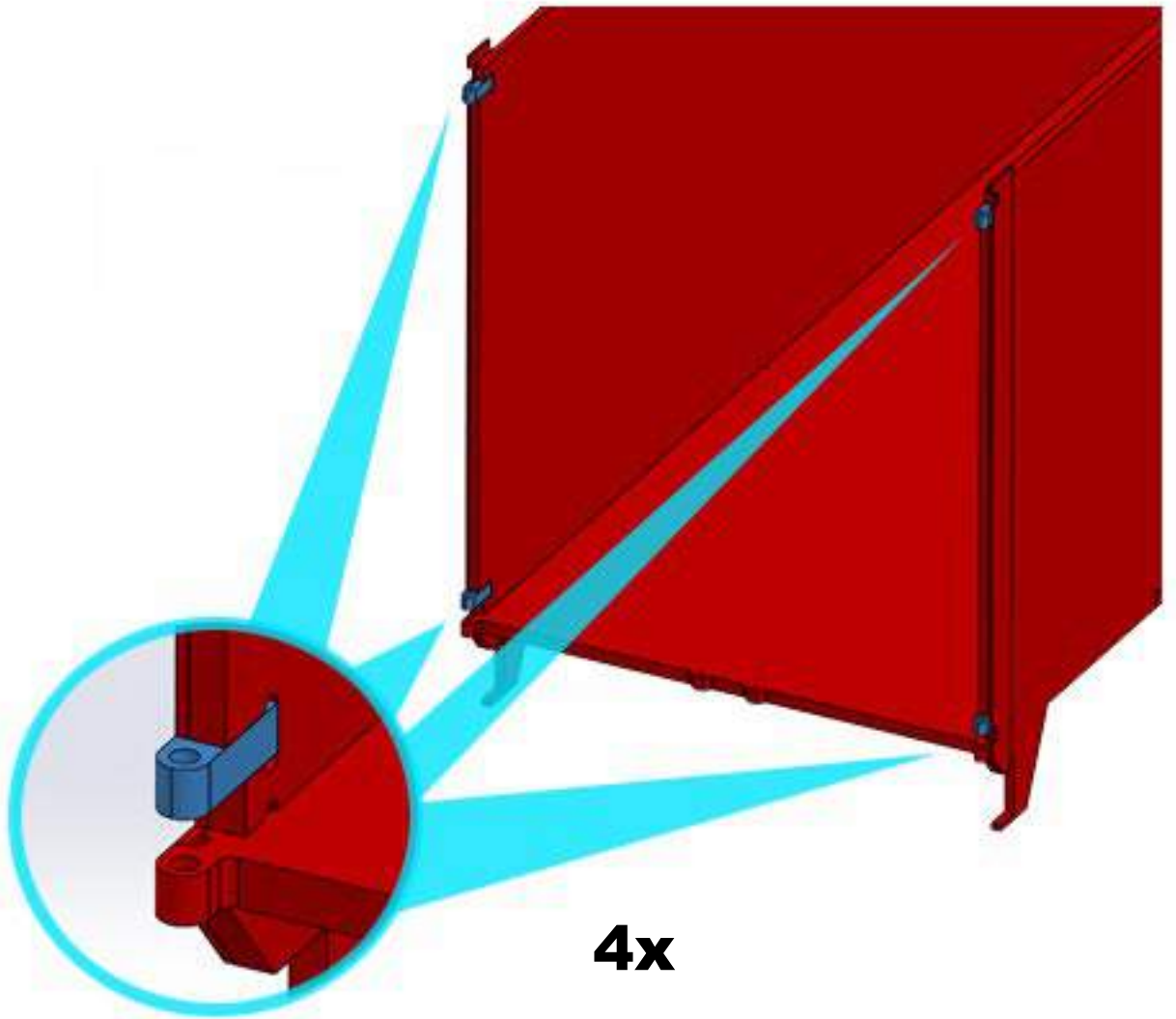

**4x**

7

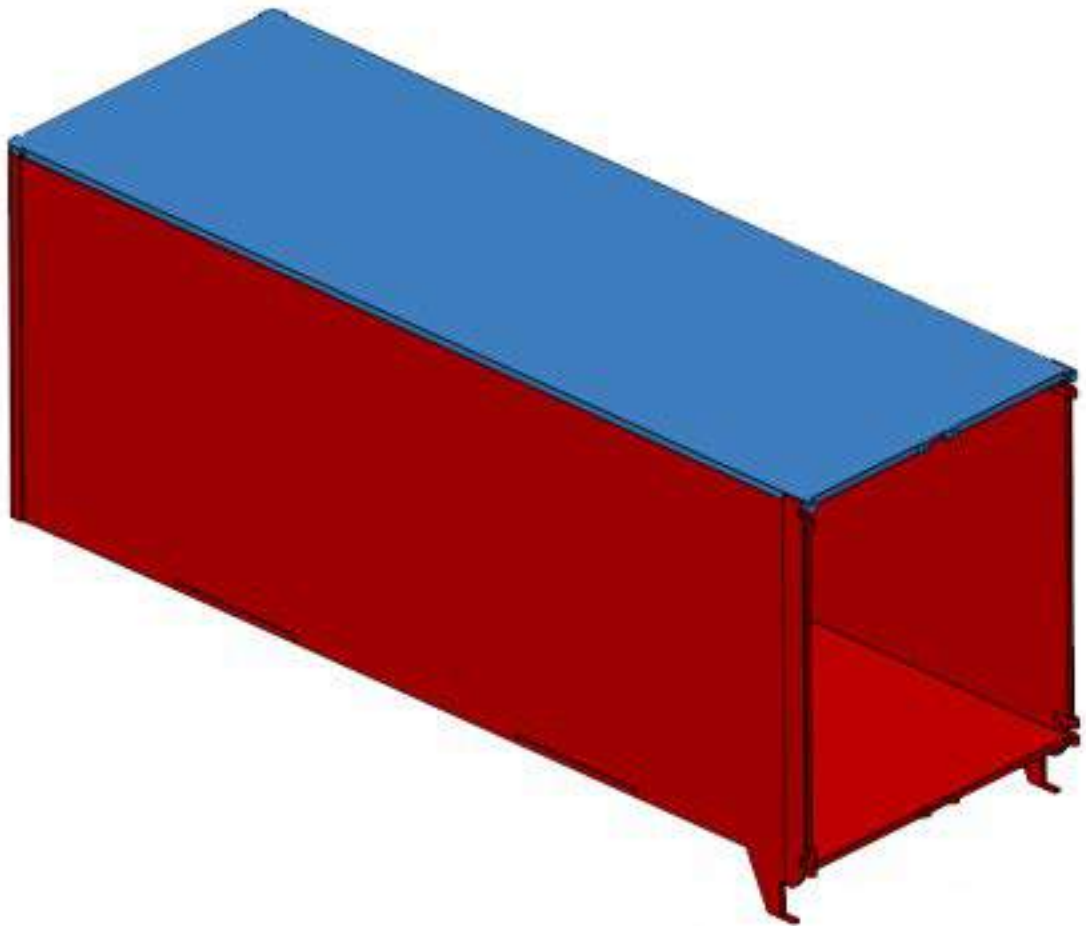

8

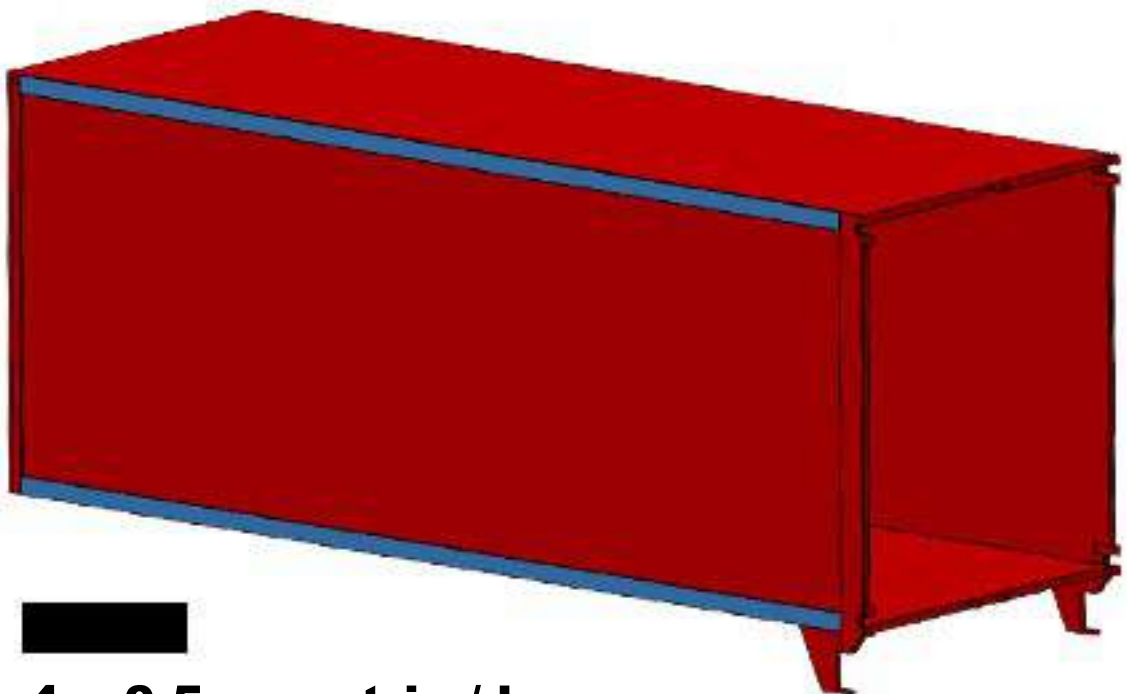

**4 x 0.5 mm strip / bar**  
**Lengte aanpassen aan bak**  
**Adjust length to body**





11

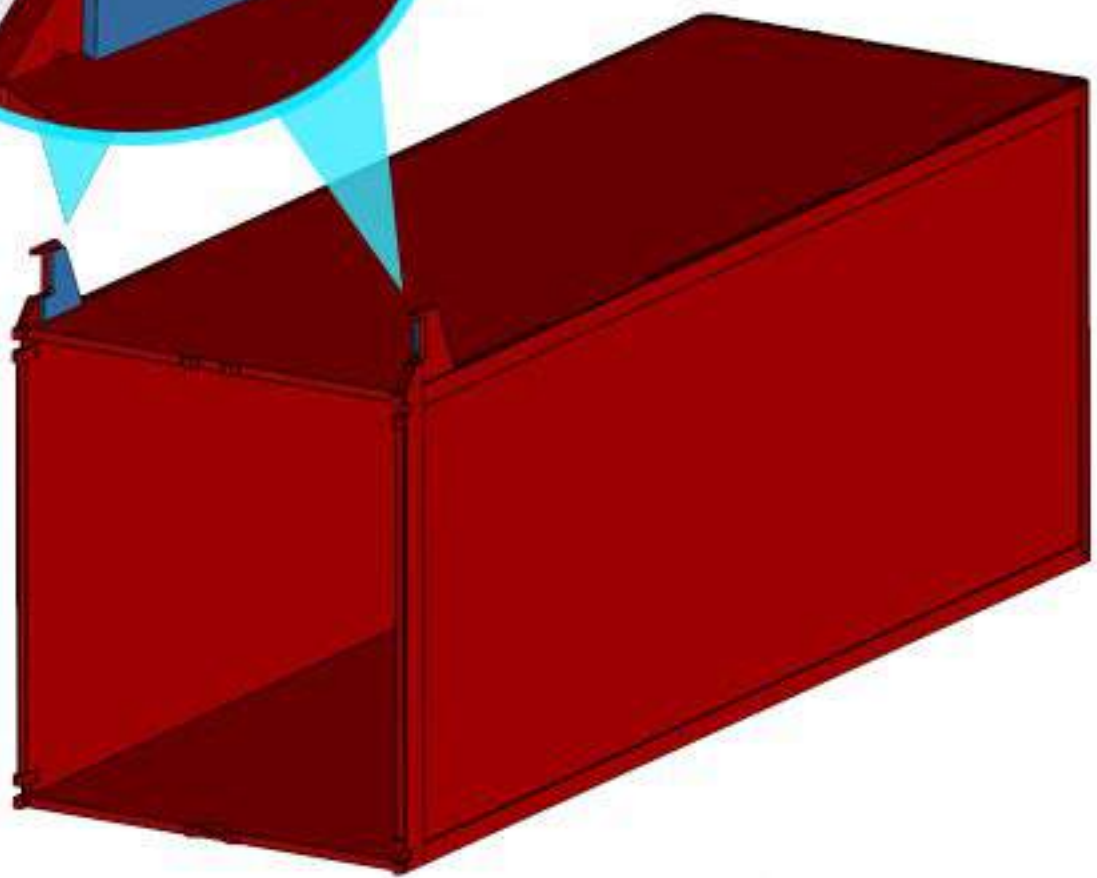

12

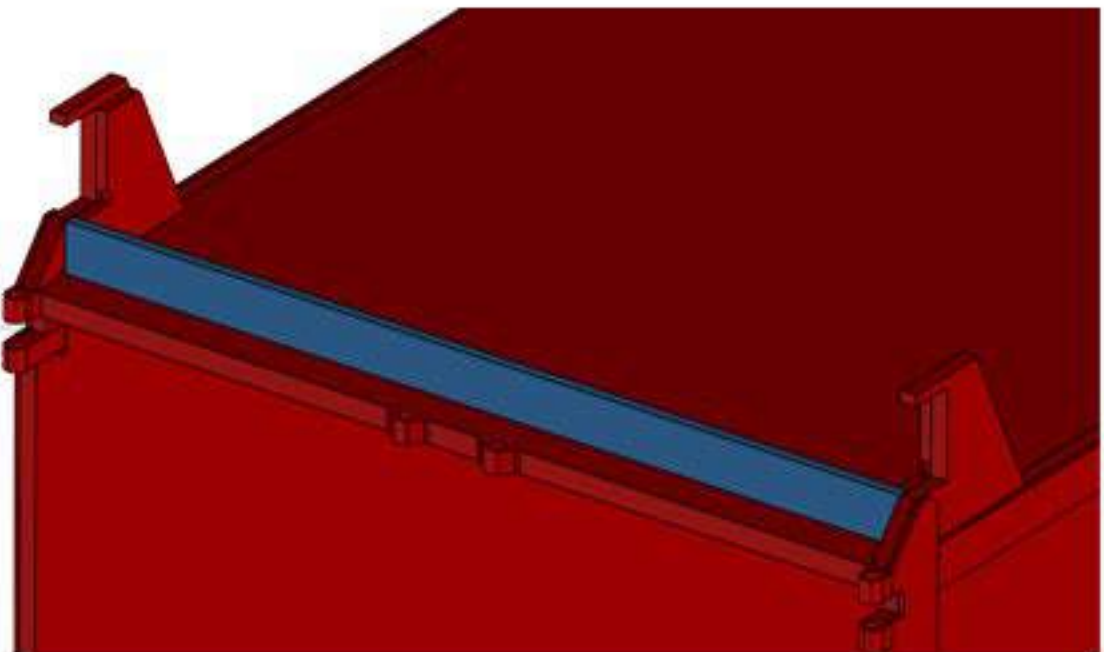

13



8 x 4mm - L = 81.5 mm

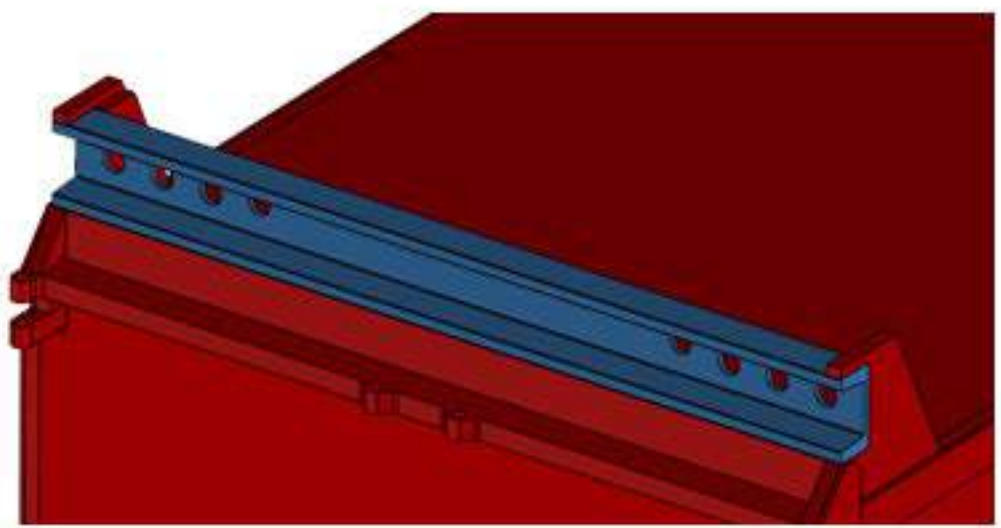

14

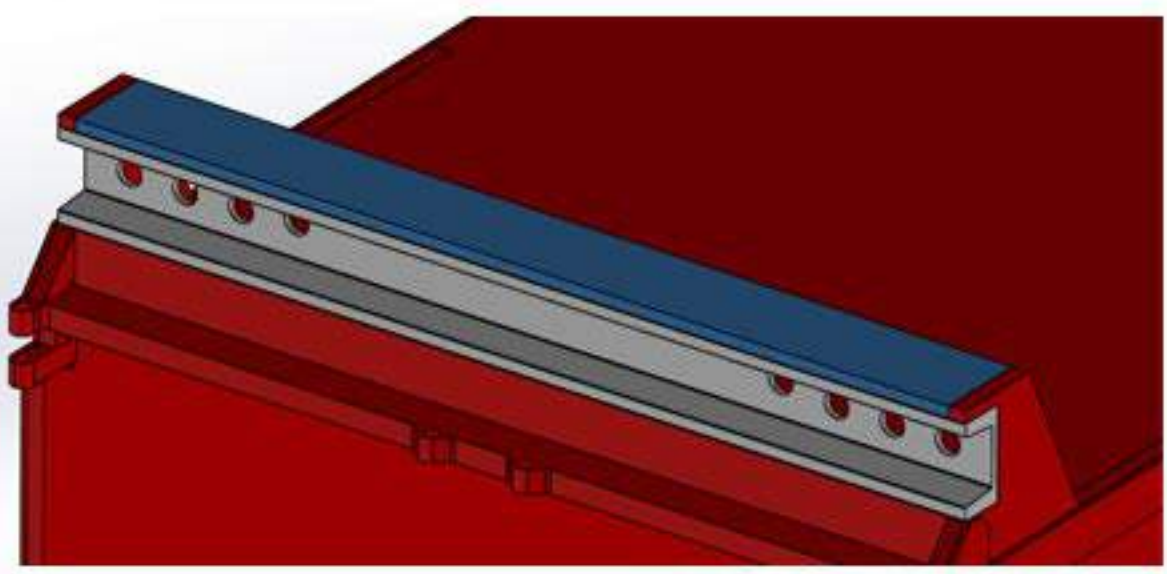



17



18

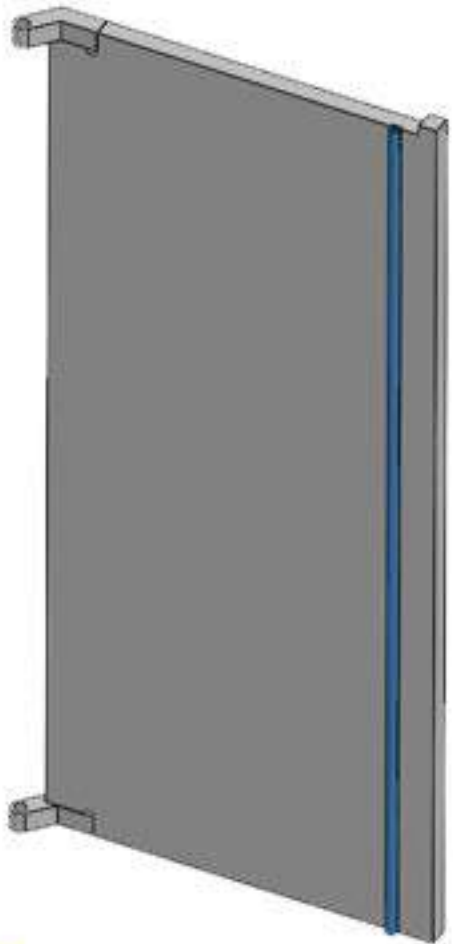

Snij al rollend aluminium pijp /  
Cut the aluminium tube while rolling

Aluminium buis / alloy tube Ø 1 mm

19

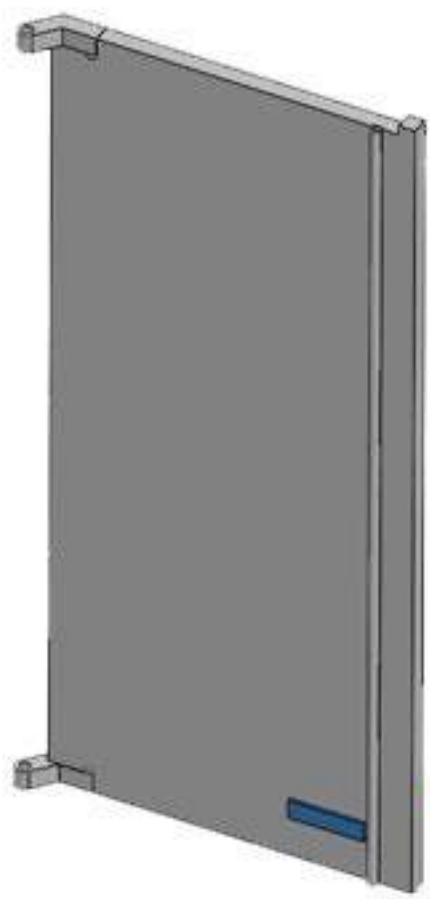

Ø 2 mm.  
L = 8 mm.

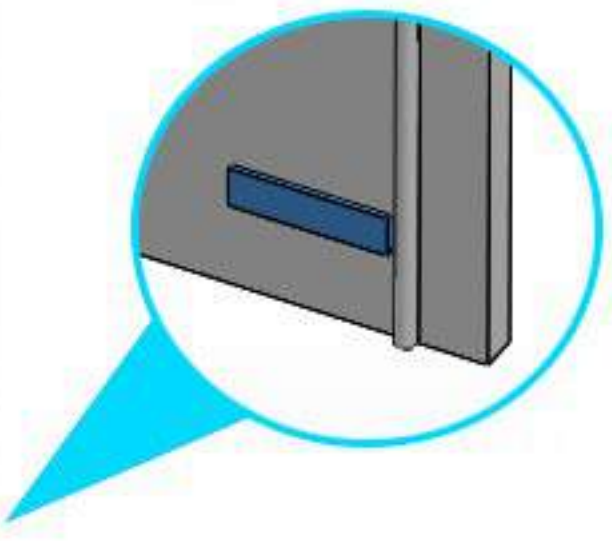

20



**Bouw nu de gespiegelde versie**

**Build the mirrored version**



